

2J5204P

CELLULAR / LTE Adhesive Mount

Key Features

CELLULAR / LTE

- 698-960 MHz
- 1710-2170 MHz
- 2500-2700 MHz

Adhesive Mount

Flexible Housing

Compact Size

High Performance

Optional Antenna Detection Resistor

Customizable Cable and Connector

Dimensions 117.4 x 12.5 x 6.5 mm



1. Antenna and electrical specifications

Parameters	CELLULAR / LTE Antenna		
Standards	2G,3G and 4G		
Band (MHz)	700/850/900	1700/1800/1900/2100	2600
Frequency (MHz)	698-960	1710-2170	2500-2700
Return Loss (dB)	~-11.5	~-14.4	~-11.5
VSWR	~2.0:1	~1.5:1	~1.8:1
Efficiency (%)	~53	~52	~41
Peak Gain (dBi)	~2	~4.1	~4.1
Average Gain (dB)	~-2.8	~-2.8	~-3.9
Impedance (Ohm)	50		
Polarisation	Linear		
Radiation Pattern	Omni-Directional		
Max. Input Power (W)	25		
Connector Type	Most RF Connectors (SMA-Male Standard)		
Cable Length	Any Cable Length (300cm Standard)		
Cable Type	Other Cables Available (LMR100 Standard)		

Antenna Measurement Conditions:

Mounted on 30 x 30 x 0.25 cm ABS Plate

200 cm LMR100 Cable

Measured in Certified CTIA 3D Anechoic Chamber

2. Mechanical and environmental specifications

Specifications	2J5204P
Mounting Type	Adhesive Mount
Dimensions (mm)	117.4 x 12.5 x 6.5
Radome	TPE
Radome color	Black, White
Operating Temperature (C)	-40 to +85
Storage Temperature (C)	-40 to +85
Substance Compliance	RoHS

3. Antenna parameters

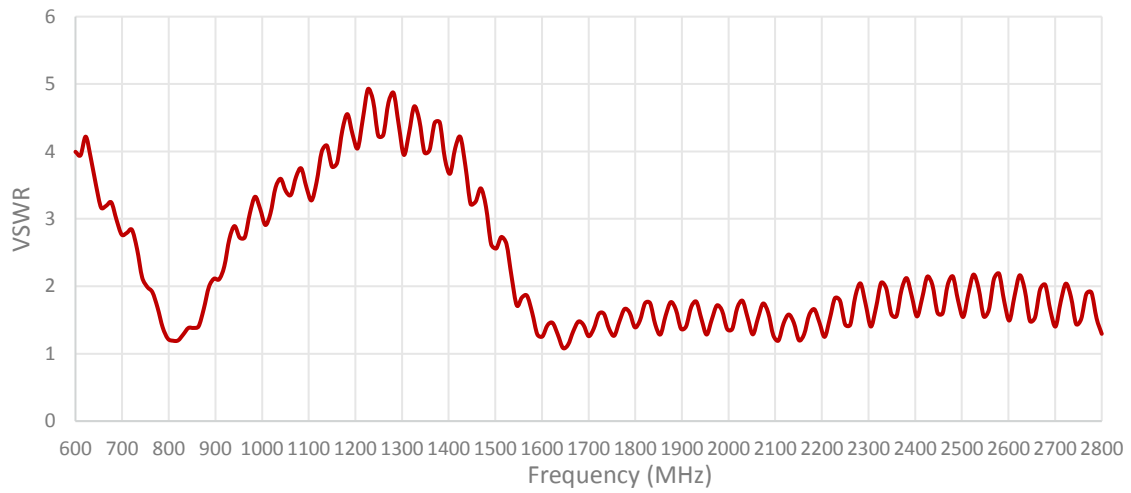
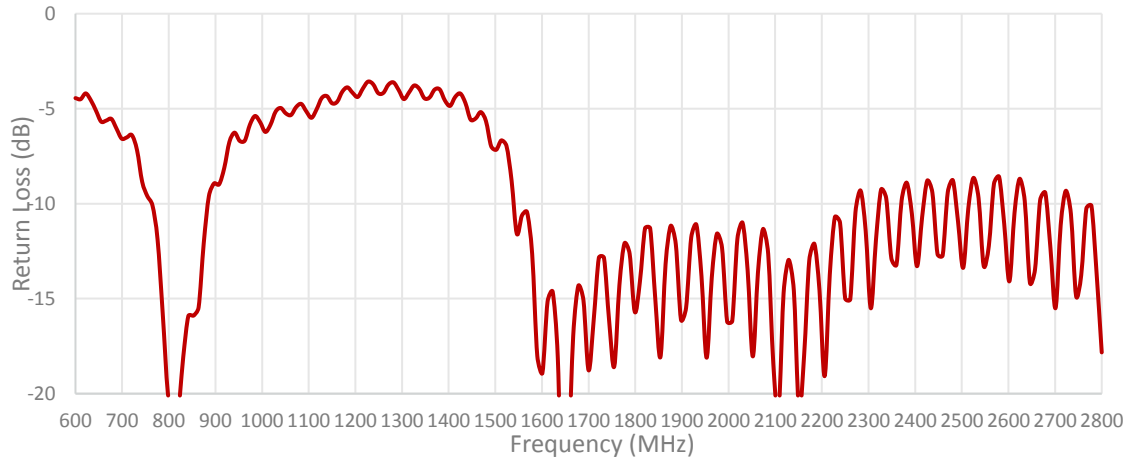

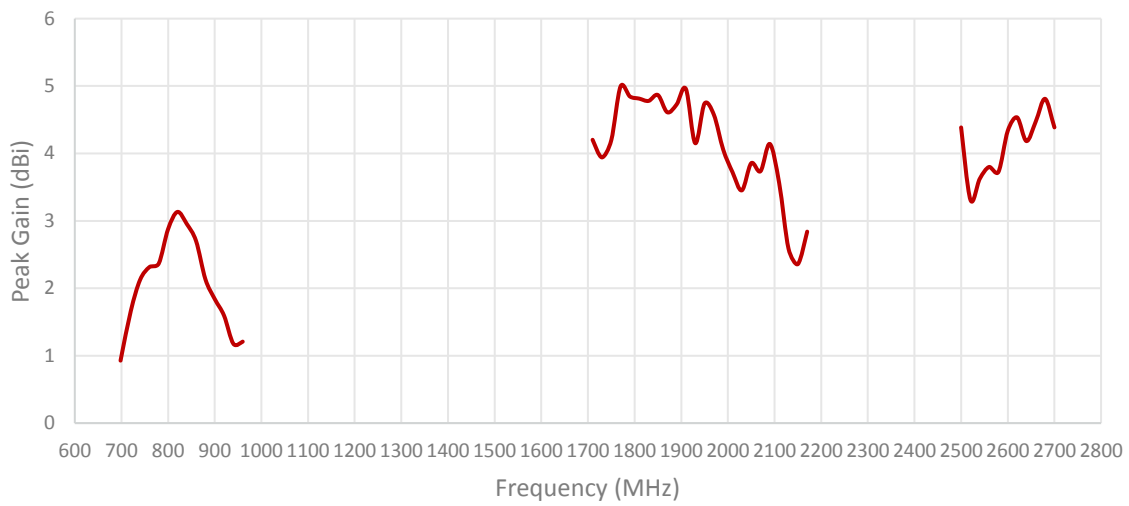
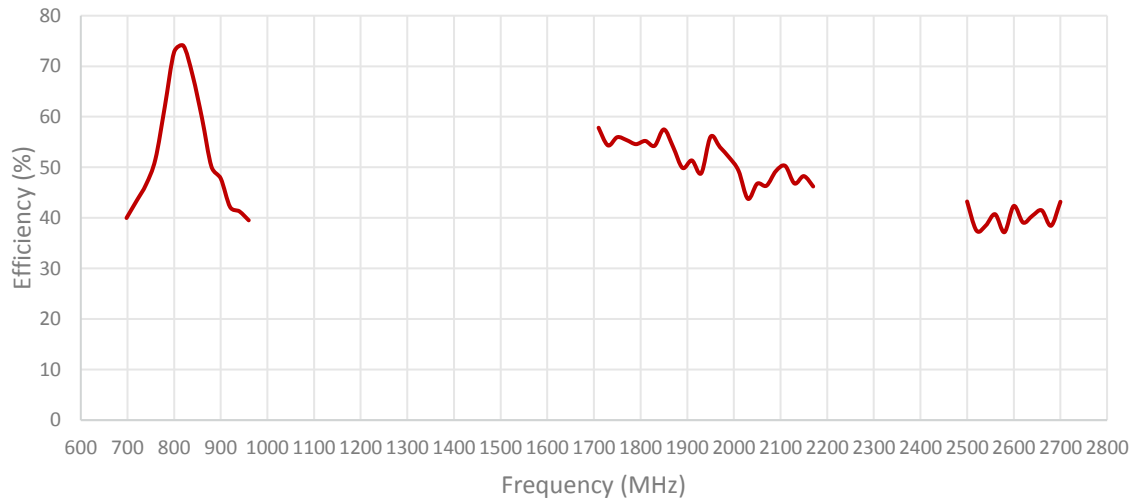

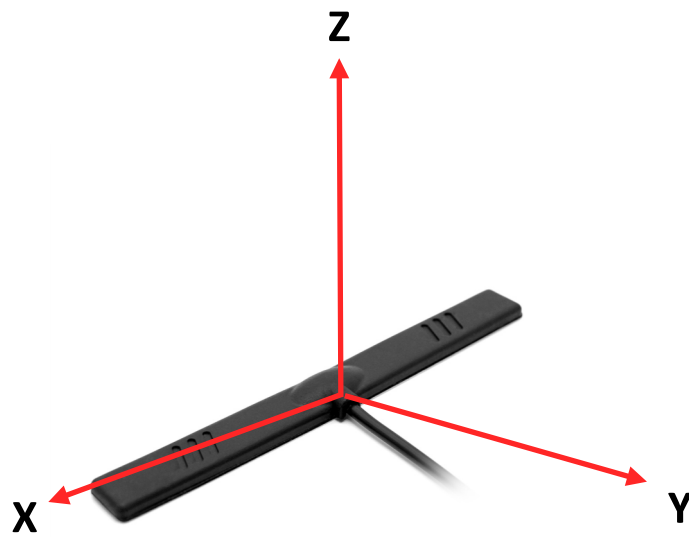
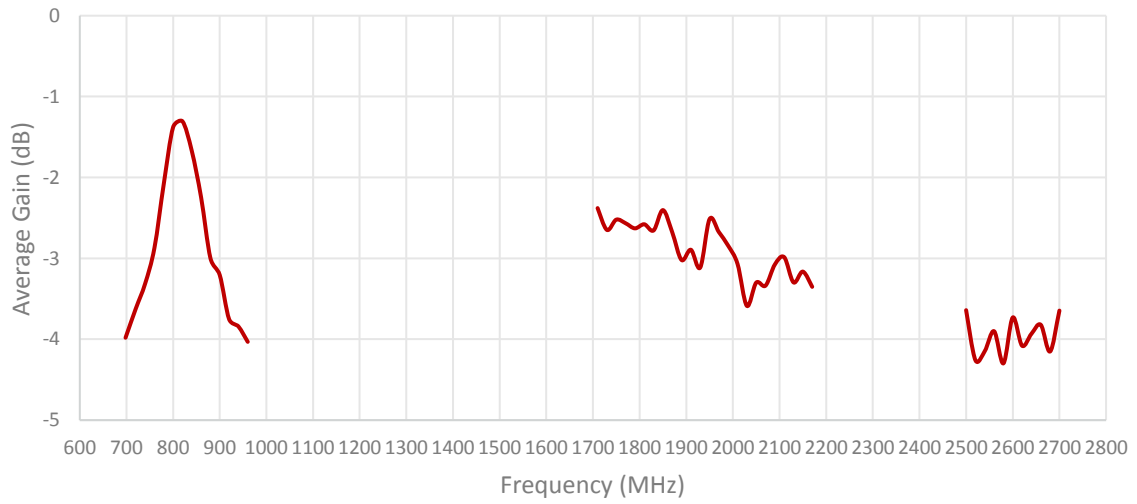

Radiation pattern reference

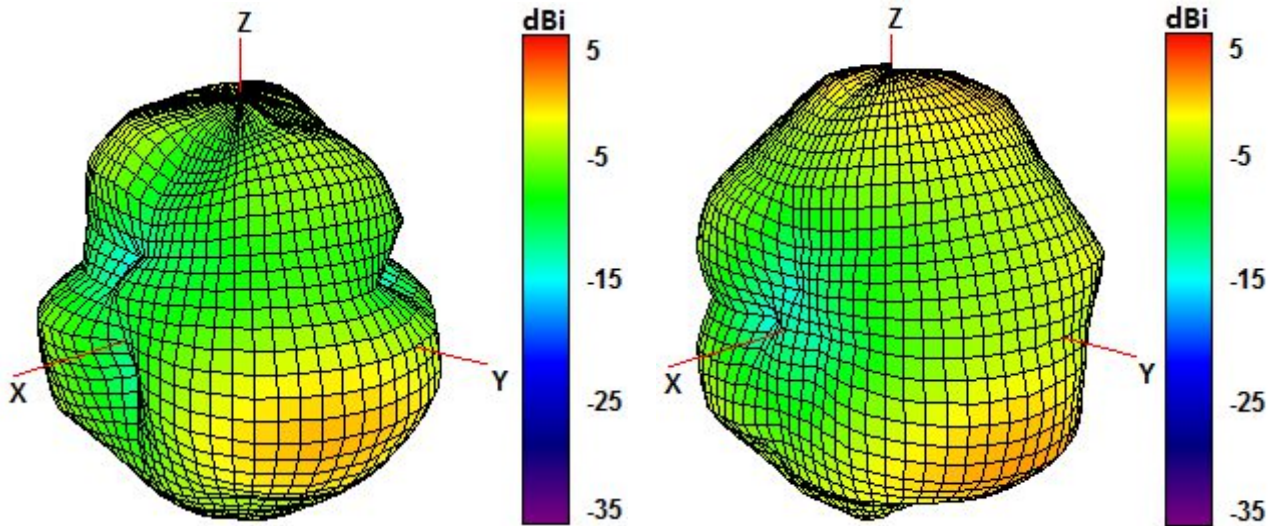

750 and 850 MHz Radiation pattern

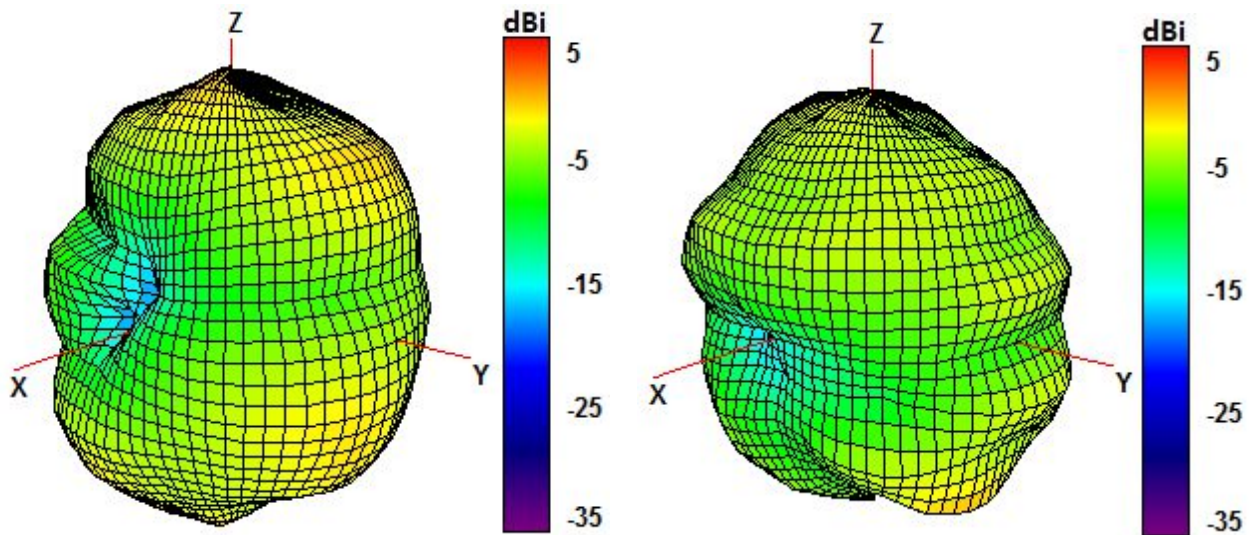

940 and 1750 MHz Radiation pattern

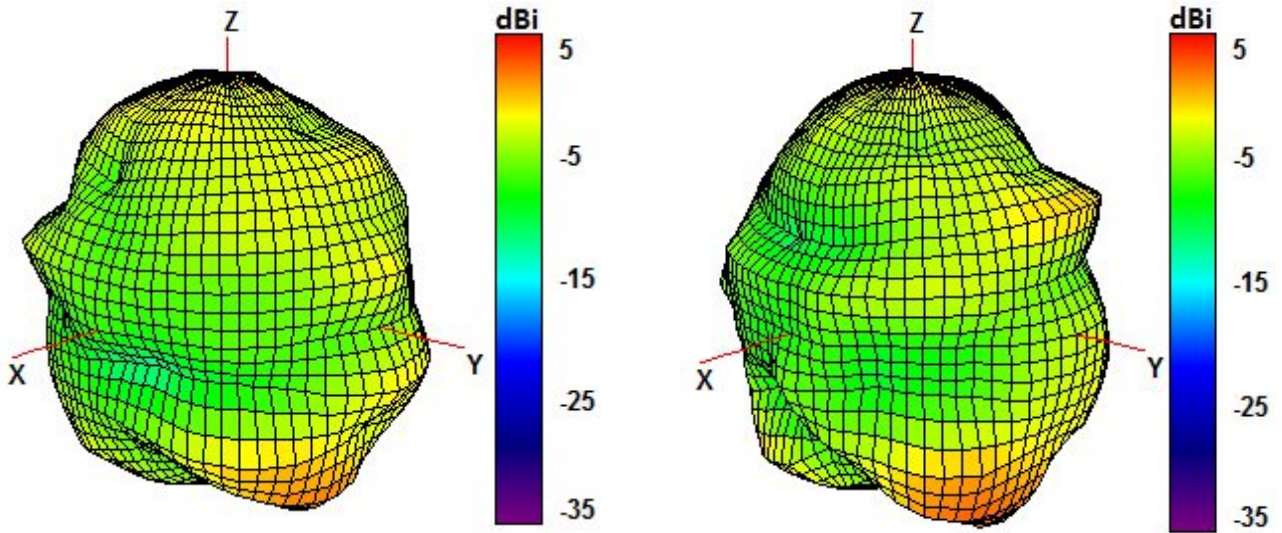

1850 and 1950 MHz Radiation pattern

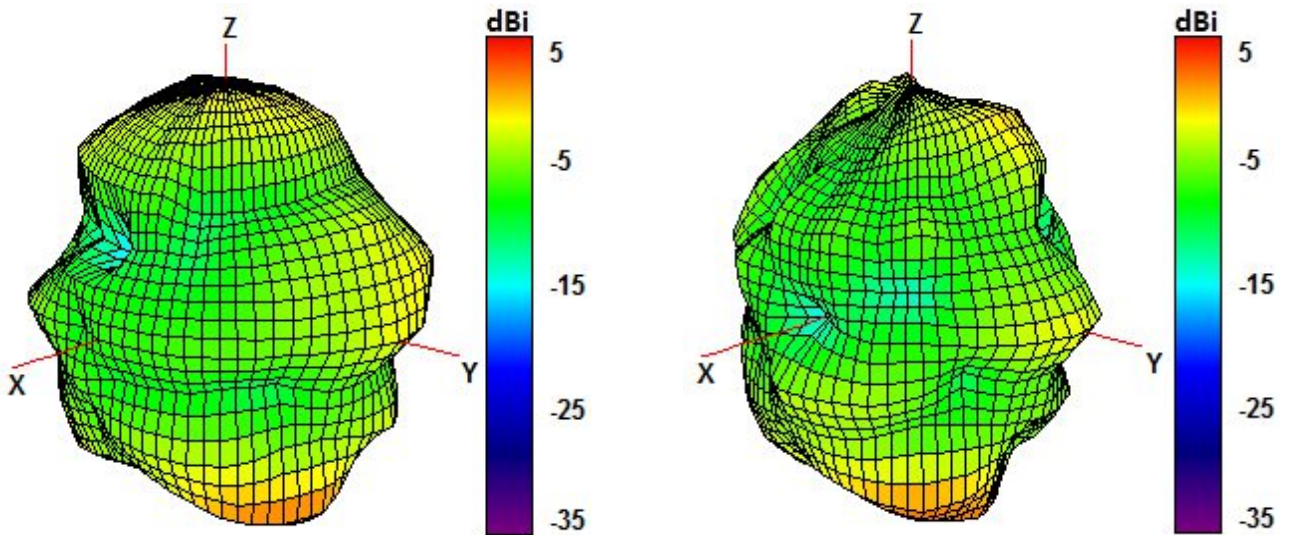

2100 and 2600 MHz Radiation pattern

4. Antenna drawings

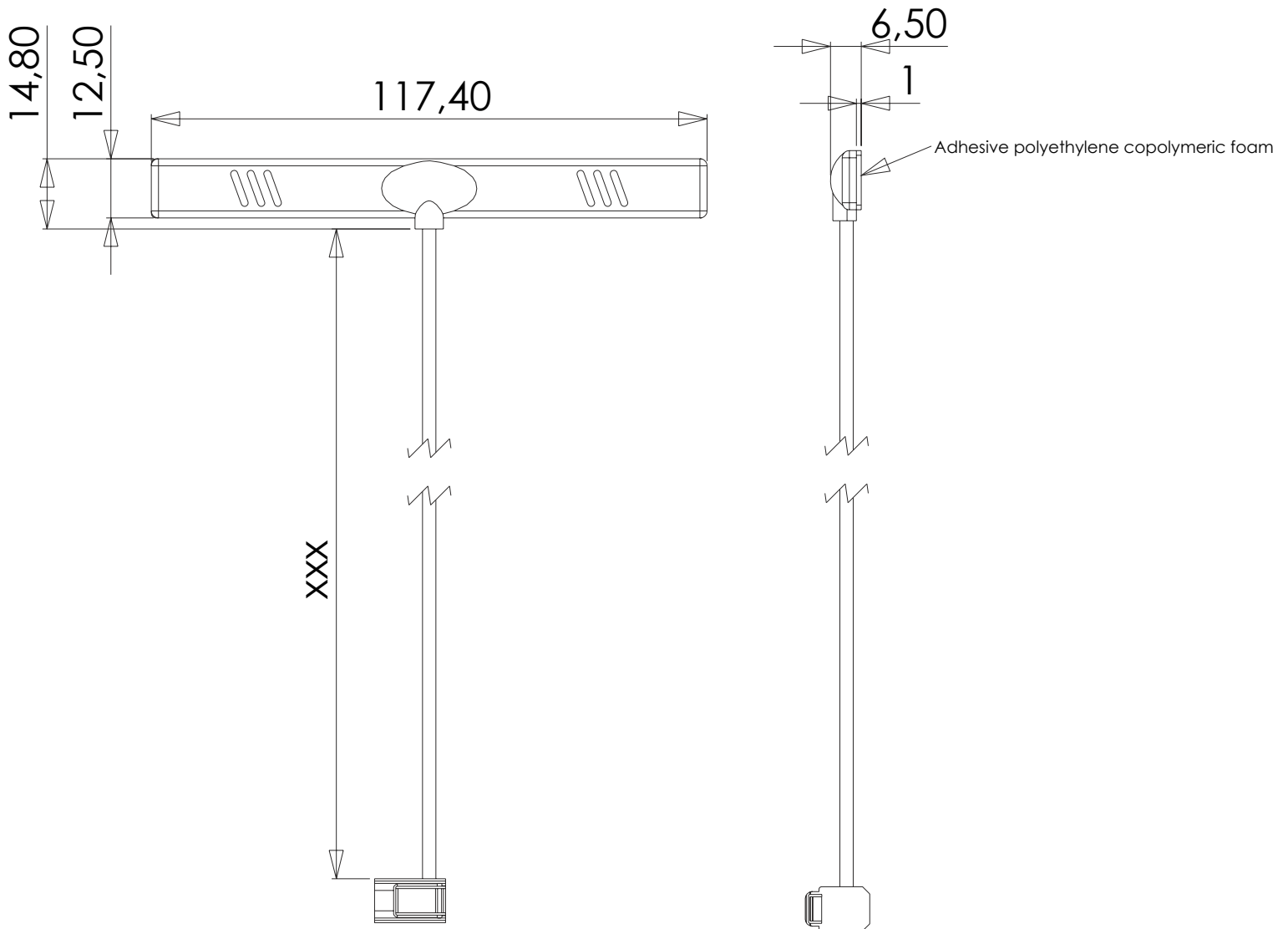

5. Antenna Images

